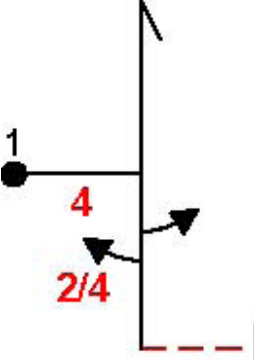
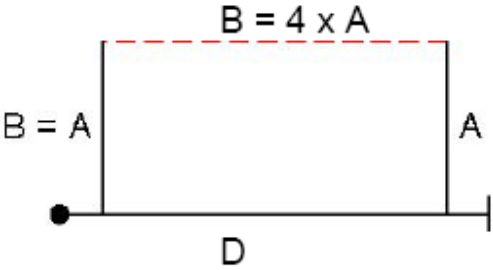



Online Judges Home Study Course

Supplement:

Due to the online program having the ability to randomize questions and laptops with small screens this document is supplied as a supplement with a clearer print of the diagrams.

The diagrams are numbered in the exam and are correlated in this document.

FIG. 1	
FIG. 2	
FIG. 3	

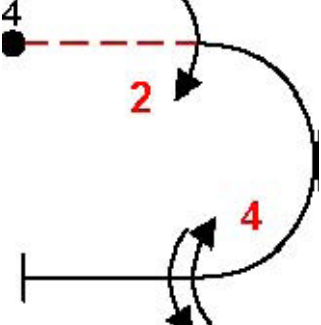
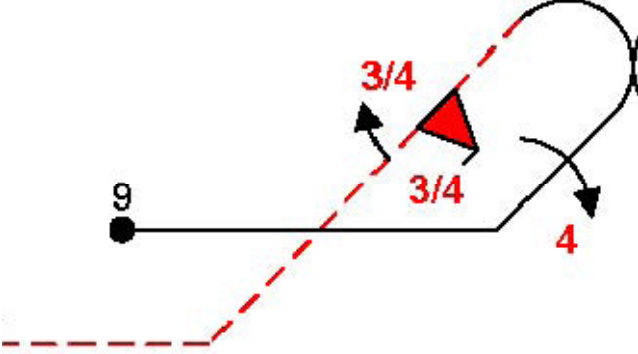
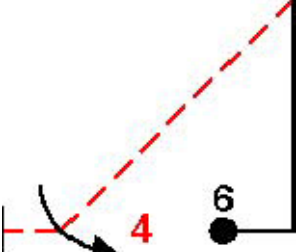
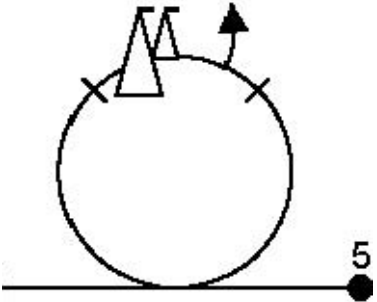
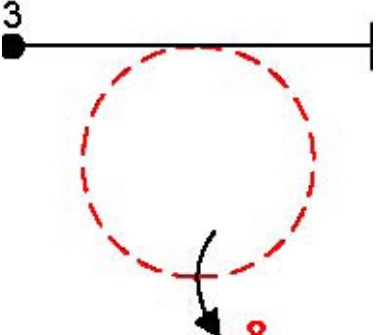
<p>FIG. 4</p>	
<p>FIG. 5</p>	
<p>FIG. 6</p>	
<p>FIG. 7</p>	
<p>FIG. 8</p>	

FIG. 9

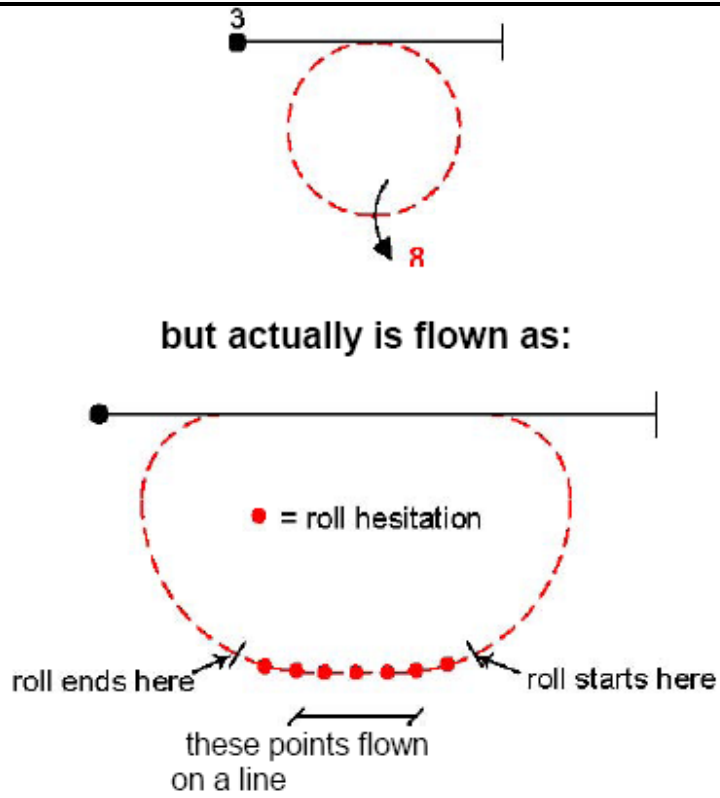


FIG. 10

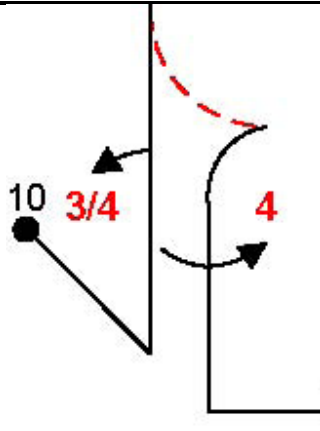


FIG. 11

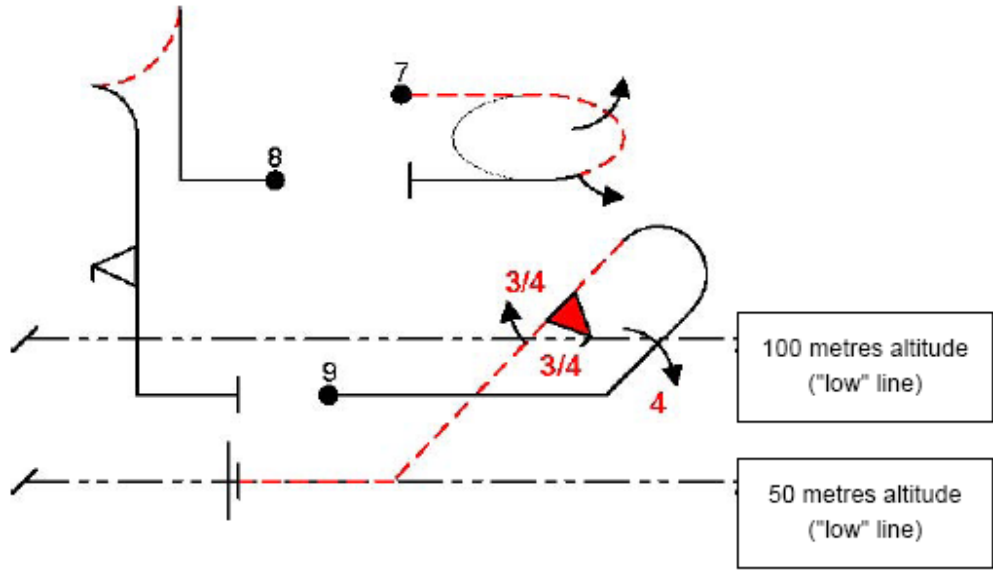


FIG.12

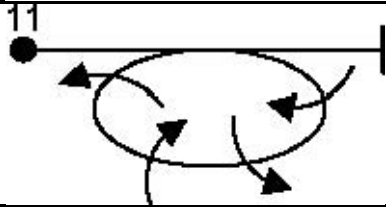
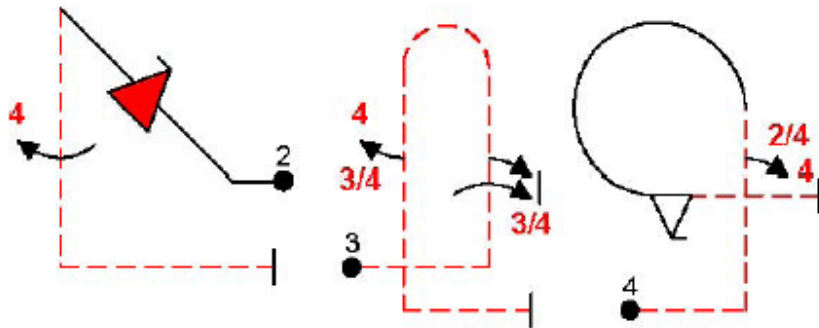


FIG.13



the competitor actually flies:

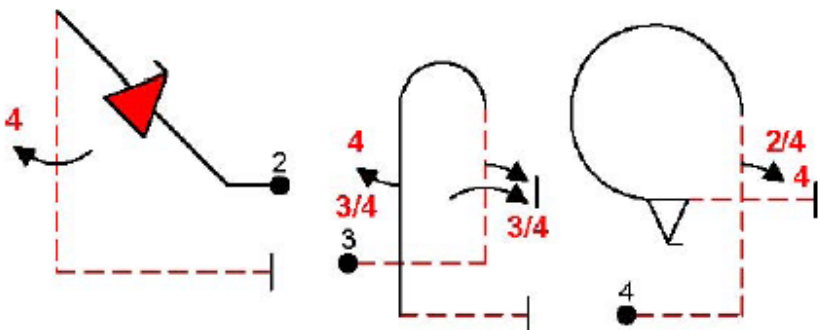


FIG. 14

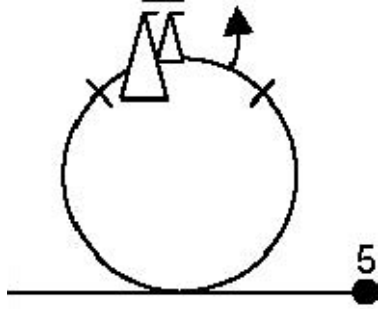


FIG.15

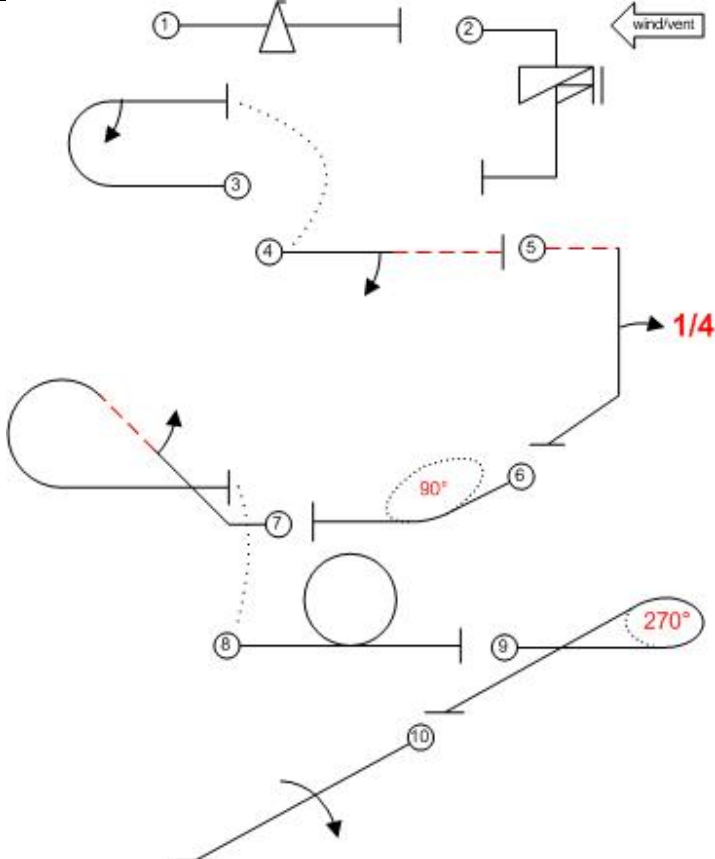


FIG. 16

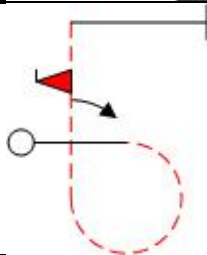
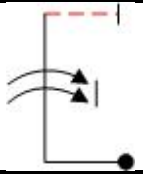


FIG. 17



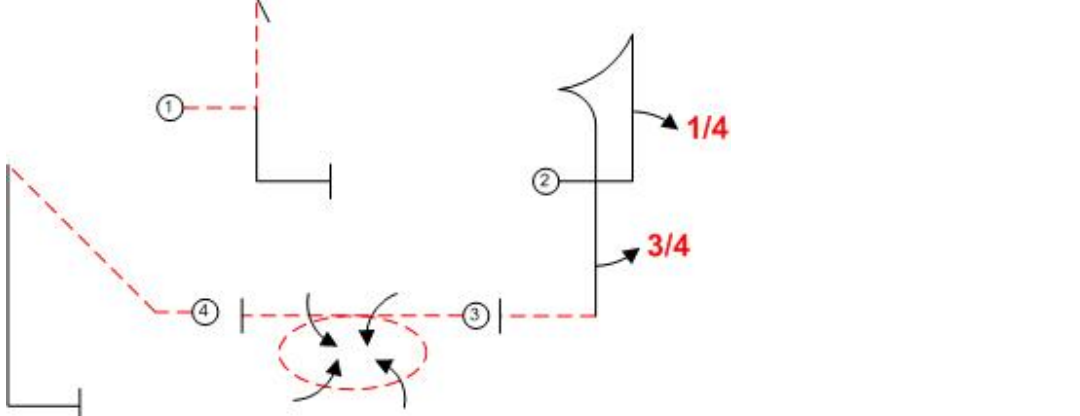





<p>FIG. 18</p>	 <p>A diagram showing the stroke order for writing a cursive letter 'a'. The letter is composed of several segments: a vertical stem on the left, a diagonal downstroke, a horizontal base, and a vertical stem on the right. A dashed red line traces the path of the pen. Numbered circles (1, 2, 3, 4) indicate the starting points of different strokes. Red arrows indicate the direction of the pen strokes. A red '1/4' is written next to the top curve of the right stem, and a red '3/4' is written next to the lower part of the right stem. A dashed red circle highlights the bottom loop of the letter, with three black arrows indicating the counter-clockwise direction of the pen strokes within this loop.</p>
<p>FIG. 19</p>	 <p>A diagram showing a cursive figure-eight stroke. It starts with a solid black dot on the left. A solid black line forms the left loop, and a dashed red line forms the right loop. Black arrows indicate the direction of the pen strokes as they move from the top to the bottom of each loop.</p>
<p>FIG. 20</p>	 <p>A diagram showing a cursive horizontal stroke. It starts with a solid black dot on the left. A dashed red line extends horizontally to the right. A small triangle is drawn above the line. Black arrows indicate the direction of the pen strokes, showing a slight curve and then a return stroke.</p>
<p>FIG. 21</p>	 <p>A diagram showing a cursive figure-eight stroke. It starts with a solid black dot on the left. A solid black line forms the left loop, and another solid black line forms the right loop. Black arrows indicate the direction of the pen strokes as they move from the top to the bottom of each loop.</p>
<p>FIG. 22</p>	 <p>A diagram showing a cursive figure-eight stroke. It starts with a solid black dot on the left. A solid black line forms the left loop, and another solid black line forms the right loop. Black arrows indicate the direction of the pen strokes as they move from the top to the bottom of each loop.</p>
<p>FIG. 23</p>	 <p>A diagram showing a cursive figure-eight stroke. It starts with a solid black dot on the left. A dashed red line forms the left loop, and another dashed red line forms the right loop. Black arrows indicate the direction of the pen strokes as they move from the top to the bottom of each loop.</p>

FIG. 24

